

EUROMACH

ANNO - YEAR - ANS
- ANO - JHAR - ANS
36°



1500 Mobile

EUROMACH

Creata nel 1977, la Euromach Srl garantisce ai clienti (50% dei quali all'estero) 36 anni di esperienza nella costruzione di escavatori ragno (oltre 2500 in tutto il mondo) destinati non solamente alle aree montane, ma anche a quelle paludose e ai canali. L'azienda è certificata ISO 9001 e collabora con i principali produttori mondiali di componenti tecnologici per il miglioramento costante e la ricerca continua di nuove soluzioni per accrescere l'efficienza e la sicurezza delle macchine, alla base del successo dell'azienda. Gli escavatori "ragno" Euromach si distinguono per la loro capacità di lavorare in terreni molto ripidi e difficili, dove l'accesso ai normali mezzi è proibito.

Set up in 1977, Euromach S.r.l grants to their customer (50% of which in foreign countries) 36 years of experience in the construction of walking excavators (more than 2500 all around the world), that are destined to work not only in mountain areas, but also in swamps and channels. The company obtained also the certification ISO 9001 and cooperates with the main world producers of technological components for constant improvement and machines' security, which are the reasons behind the company success. Euromach excavators are ideally suited to work on very steep or rough-terrain sites, where access is severely restricted.

Crée en 1977, Euromach Srl garantie aux clients (dont 50% à l'étranger) 36 années d'expérience dans la construction des pelles araignées (plus de 2500 dans le monde entier) aux terrains de montagne, mais aussi terrains maraîchers et aux cours d'eau. L'entreprise est certifiée ISO 9001 et collabore avec les principaux producteurs mondiales de composants technologiques pour une amélioration constante et une recherche continue des nouvelles solutions dans le but d'augmenter l'efficacité et la sécurité des machines, qui sont à la base du succès de l'entreprise. Les pelles araignées Euromach se distinguent pour leur capacité à travailler dans des terrains très raides et difficiles, où l'accès aux moyens traditionnels est interdit.

Die Firma Euromach Srl, wurde im Jahr 1977 gegründet und bringt somit ihren Kunden, welche sich zu 50% im Ausland befindet, eine Erfahrung von über 36 Jahren in der Herstellung von Schreitbaggern entgegen und bürgt daher für technologisch innovative Produkte. Diese Schreitbagger sind für Einsätze konstruiert, welche für andere Maschinen nicht oder nur schwer durchführbar sind. Diese Einsätze beschränken sich nicht nur auf Bergland, Euromach Schreitbagger eignen sich auch besonders gut für Einsätze in sumpfigen Gebieten und Kanälen. Die ISO 9001 Zertifikat gewährleistet die Verwendung von technologischen Komponenten marktführender namhafter Hersteller und eine stetige Forschung und Weiterentwicklung um die Leistung, Standhaftigkeit und Sicherheit der Maschinen zu erhöhen, was nicht zuletzt den Erfolg der Firma begründet.



TIGROTTO



1300 SUPER JOLLY



3500 MOBILE



5500 MOBILE



6500 MOBILE



8500 MOBILE

1500 Mobile



Il 1500 Mobile è un escavatore di peso ridotto studiato per essere trasportato interamente con un elicottero senza bisogno di dividere i vari componenti. Inoltre la particolarità del brandeggio del braccio permette a questo escavatore di lavorare anche in spazi molto ristretti.

The excavator 1500 Mobile is a small weight machine designed to be transported entirely with a helicopter without the need to divide his components. In addition, the special boom slewing allows this excavator to work in very restricted spaces.

La pelle araignée 1500 Mobile a été étudié, grâce à son poids réduit, pour être hélicoptée entièrement sans être démontée. De plus, l'orientation particulière du bras permet à cette machine de travailler dans des milieux d'accès difficiles.

Der Schreitbagger 1500 Mobile ist eine Maschine mit einem reduzierten Gewicht, welcher vollständig mit einem Hubschrauber befördert werden kann, ohne in seine Komponenten aufteilen zu müssen. Darüber ermöglicht die Armschwenkung des Baggers auch in engen und geschlossenen Räumen zu arbeiten.

Escavatori Euromach / Euromach excavators Pelles Euromach / Bagger Euromach



2500 MOBILE



R45



R55



R65 SUPER POWER



R85 L



R105



R125



R145

EUROMAGH



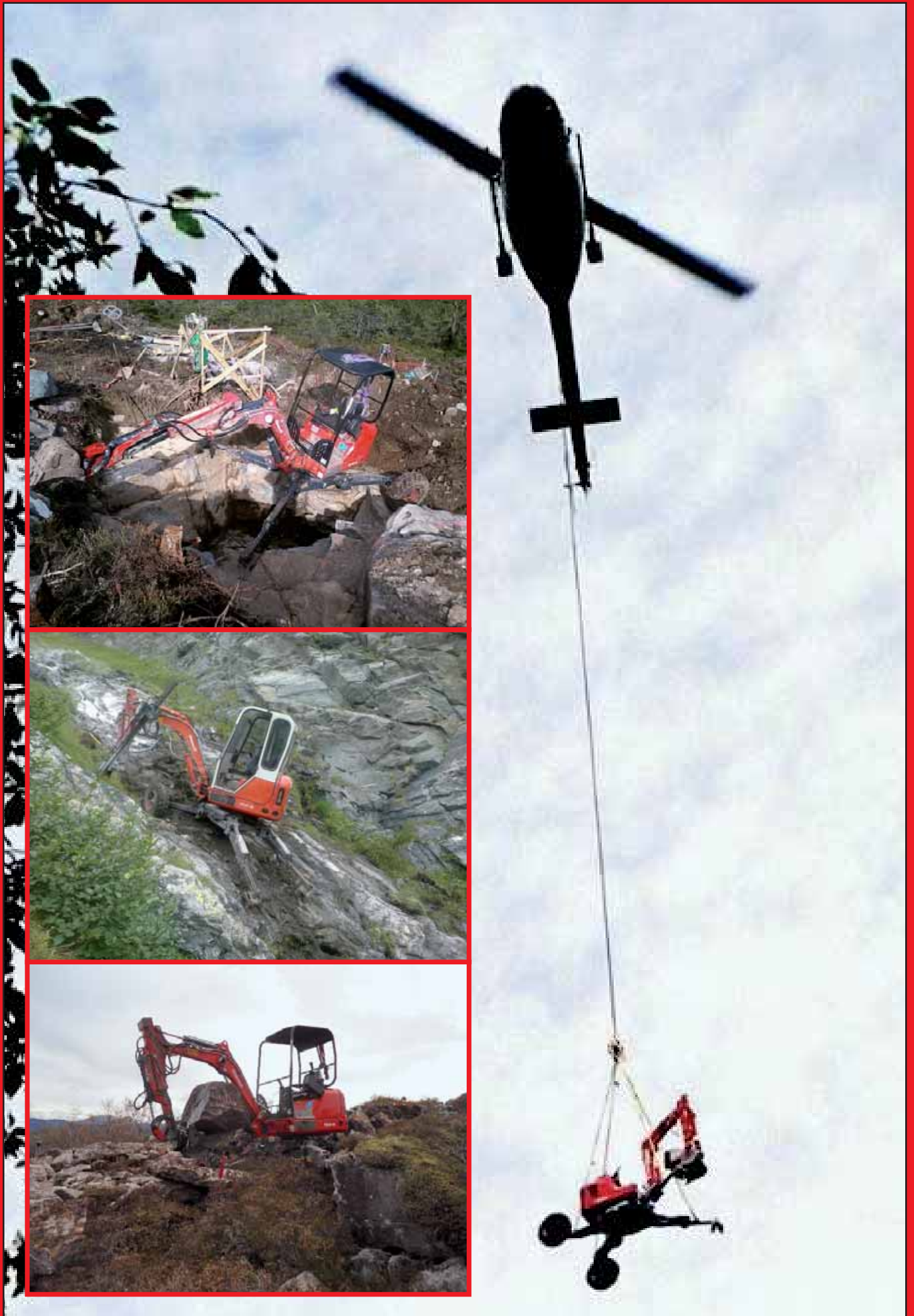



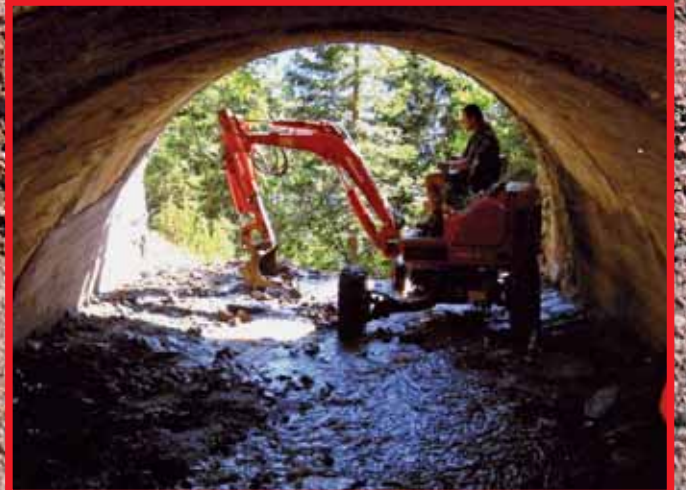

Motore / Engine / Moteur / Motor



Modello: Kubota 1105
Tipo: Diesel 4 tempi raffreddato ad acqua
Numero cilindri: 3
Cilindrata: 1123 cm³
Potenza massima: 21 Hp (15,5 kW)
Tensione alimentazione: 12V
Alternatore: 40 A/h

Model: Kubota 1105
Type: 4 strokes water-cooled turbo Diesel
Cylinders number: 3
Displacement: 1123 cm³
Max power: 21 Hp (15,5 kW)
Electric system: 12V
Generator: 40 A/h

Modèle: Kubota 1105
Type: Turbo Diesel 4 temps refroidissement par liquide
Nombre de cylindres: 3
Cylindrée: 1123 cm³
Puissance maximum: 21 Hp (15,5 kW)
Tension du moteur: 12V
Générateur: 40 A/h

Modell: Kubota 1105
Typ: Viertakt-Turbodieselmotor mit Flüssigkeitskühlung
Zylinderanzahl: 3
Hubraum: 1123 cm³
Höchstleistung: 21 Hp (15,5 kW)
Speisespannung: 12V
Wechselstromgenerator: 40 A/h

Kubota®

PERFORMANCE CURVE

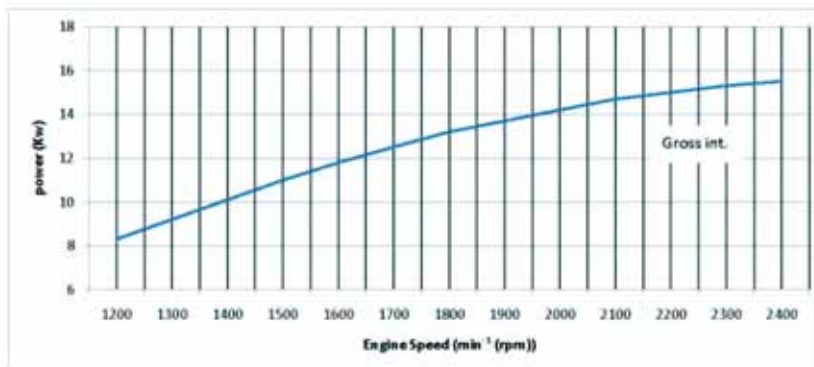
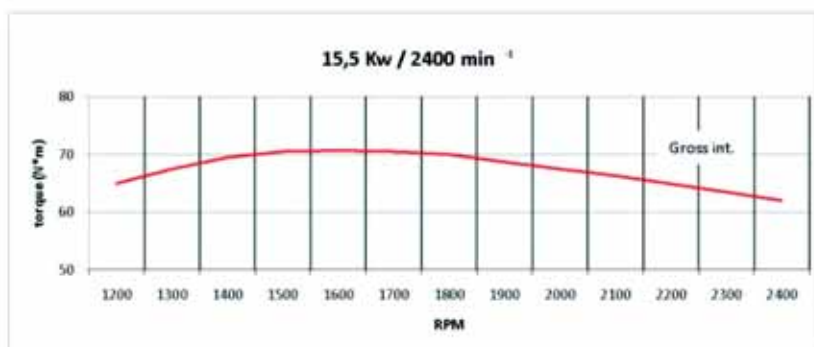

Cabina / Cab / Cabine / Kabine STANDARD



Cabina / Cab / Cabine / Kabine OPTION



1500 Mobile

DATI PRINCIPALI

Massa operativa = 1.900 Kg
Massa operativa con cabina = 2.100 Kg
Sfilo idraulico del braccio = 0,50 Mt
Forza di strappo = 17,4 kN
Forza di penetrazione = 10,7 kN
Rotazione continua su 360°
Velocità di rotazione = 8,7 rpm
Velocità di marcia = 2,6 Km/h
Funzionamento con gasolio per autotrazione
Capacità serbatoio gasolio = 26 Lt
Capacità serbatoio olio idraulico = 35 Lit

n. 3 pompe a portata fissa (portata complessiva 48 Lt/min).
Impianto principale con valvola distributrice a 7 sezioni componibili pilotata idraulicamente.
Pressione circuito principale = 200 bar
Cilindri con ammortizzatori a fine corsa.
Valvole di blocco su tutti i cilindri parte bassa (zampe).
Rotazione torretta con motore idraulico e riduttore epicicloidale con freno lamellare negativo e valvola ammortizzatrice di frenata.
Trazione posteriore mediante 2 riduttori ruota, completi di freno negativo con possibilità di sgancio meccanico.
Pressione circuito di posizionamento = 170 bar.
Brandeggio braccio 50°/90°

Tettuccio omologato ROPS.

OPZIONE: Cabina antiribaltamento ROPS insonorizzata, fornita di cristalli temprati e colorati, tergilcristallo elettrico, faretto di lavoro, avvisatore acustico e riscaldamento.

Sedile meccanico.

Manipolatori con pulsanti.

OPZIONE: manipolatori con mini-joystick.

MAIN DATA

Operating mass = 1.900 Kg
Operating mass with the cab = 2.100 Kg
Hydraulic extension of the boom = 0,50 Mt
Tearing resistance = 17,4 kN
Penetration force = 10,7 kN
Continuous 360° rotation
Rotation speed = 8,7 rpm
Driving speed = 2,6 Km/h
Runs on fuel oil
Fuel tank capacity = 26 Lt
Hydraulic oil tank capacity = 35 Lit

N. 3 fix displacement pumps (total displacement 48 L/min).
Traction pump with total displacement 160 L/min.
Main system with hydraulically-controlled modular 7 section control bank valve.
Main circuit rated pressure 200 bar
Cylinders with end of stroke shock-absorbers.
Safety valves on all the cylinders in the lower section (legs).
Turret rotation by means of hydraulic motor and epicycloidal reduction gear with negative lamina brake and cushioning valve.
Rear drive with two wheel reduction gears complete with negative brake and mechanical release.
Positioning circuit rate pressure = 170 bar.
Boom slewing 50°/90°

ROPS roof.

OPTION: Anti-roll cabin ROPS sound proofed, with coloured and tempered glass windows, electric wiper, working light, acoustic horn and heater.

Mechanical seat.

Manipulators with buttons.

OPTION: manipulators with mini-joysticks.

DONNES PRINCIPALES

Masse opérationnelle = 1.900 Kg
Masse opérationnelle avec cabine = 2.100 Kg
Extension hydraulique du bras = 0,50 Mt
Force d'enlèvement = 17,4 kN
Force de pénétration = 10,7 kN
Rotation continue sur 360°
Vitesse de rotation = 8,7 rpm
Vitesse de marche = 2,6 Km/h
Fonctionnant avec gazole pour transport routier.
Capacité réservoir gazole = 26 Lt
Capacité réservoir huile hydraulique = 35 Lit

N. 3 pompes à débit fixe (débit totale 48 L/min).
Installation principale avec clapet de distribution à 7 sections modulaires à actionnement hydraulique.
Pression du circuit principale = 200 bar
Vérins avec amortisseurs de fin de course.
Vanne de blocage sur tous les vérins de la partie inférieure (pattes).
Rotation tourelle avec moteur hydraulique et réducteur épicycloidal avec frein à lamelles négatif et vanne amortisseuse de freinage.
Traction arrière moyennant de deux réducteurs de la roue munis de frein négatif avec possibilité de déclenchement mécanique.
Pression du circuit de positionnement = 170 bar.
Pivotement du bras 50°/90°

Toit homologué ROPS.

OPTION: Cabine anti-renversement ROPS insonorisée, équipée de glaces trempées et colorées, essuie-glace électrique, phare de travail, klaxon et chauffage.

Siège mécanique.

Manipulateurs avec boutons.

OPTION: manipulateurs avec mini-joysticks.

HAUPTDATEN

Betriebsmasse = 1.900 Kg
Betriebsmasse mit Kabine = 2.100 Kg
Hydraulische Verlängerung des Armes = 0,50 Mt
Reißkraft = 17,4 kN
Durchschlagkraft = 10,7 kN
Kontinuierliche Drehung bei 360°
Drehgeschwindigkeit = 8,7 rpm
Fahrgeschwindigkeit = 2,6 Km/h
Betrieb mit Dieselöl für Selbstantrieb
Kapazität Treibstofftank = 26 Lt
Kapazität Hydroöltank = 35 Lit

N. 3 Pumpen mit Festleistung (gesamt Leistung 48 L/min).
Hauptanlage mit hydraulisch gesteuertem Verteilerventil mit 7 zusammensetzbaren Schnitten.
Nennndruck des Hauptkreislaufs = 200 bar
Zylinder mit Endanschlagsdämpfer.
Sperrventil auf allen Zylindern des unteren Bereichs (Bügeln).
Drehkopfdrehung mit Hydromotor und Planetenuntersetzungsgetriebe mit negativer Lamellenbremse und Bremsungsdämpfventil.
Hinterradantrieb über zwei Räderuntersetzungsgetriebe, vollständig mit negativer Bremse mit möglicher mechanischer Entkupplung.
Nennndruck des Positionierungskreislaufs = 170 bar.
Armschwenkung 50°/90°

Zugelassene Führersitzhaube ROPS.

OPTION: Kippsichere Kabine (ROPS) schallgedämpt, ausgestattet mit gehärtete und gefärbten Scheiben, elektrischer Scheibenwischer, Betriebscheinwerfer, Hupe und Heizung.

Mechaniksitz.

Manipulatoren mit Knöpfen.

OPTION: Manipulatoren mit Mini-joystick.

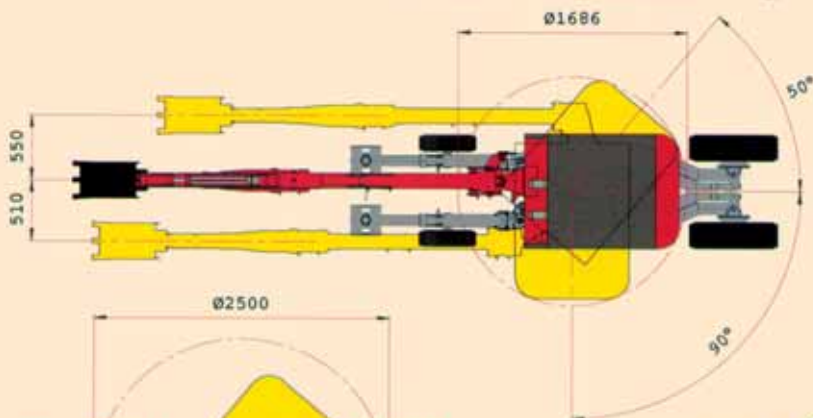
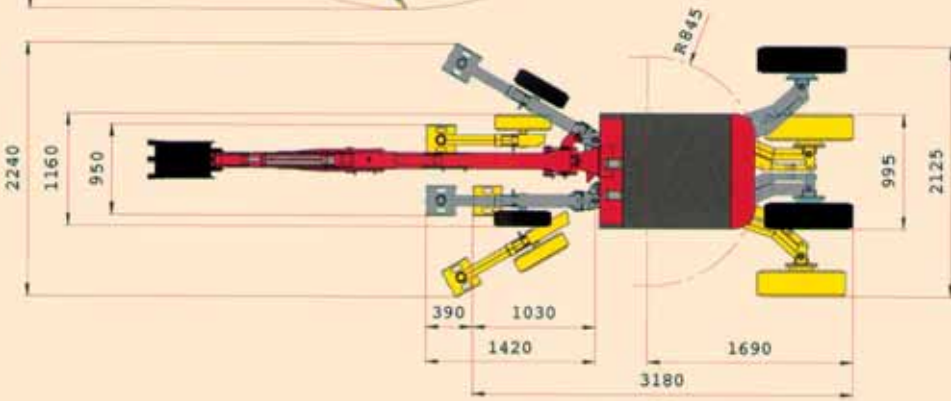
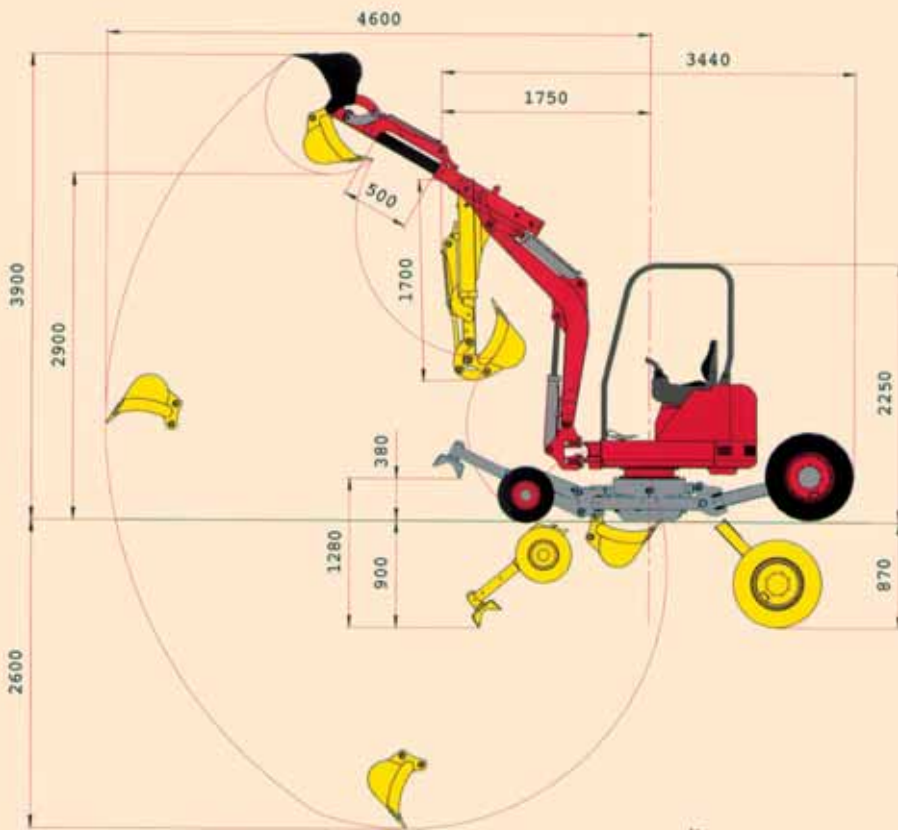



1500 Mobile

EUROMACH S.R.L.
25018 MONTICHIARI (Brescia)
ITALY
Via Gabriele D'Annunzio, 28/30
Phone 0039(0)-30-9960527
Fax 0039(0)-30-9960363
www.euromach.com
e-mail: euromach@euromach.com



- A fronte di una continua ricerca tecnologica, i dati possono cambiare senza preavviso. Contattare il nostro Ufficio Commerciale per ulteriori informazioni.
- Because of continuous technology research data can change without notice. Please, contact our Commercial Dept. for further information.
- Vue la recherche technologique continue, les données peuvent changer sans préavis. Contacter notre Bureau Commercial pour des autres informations.
- Wegen technischer Forschung, können die Daten fristlos ändern. Unser Vertrieb erteilt Ihnen gerne weitere Auskünfte, bitte rufen Sie an.

Ed01/13 - Rev 0